

DEVELOPMENT OF A SOLAR CELL MODEL WITH A PROGRAMME FOR CIRCUIT ANALYSIS - SPICE

Andrej Hanžič, Jože Voršič

University of Maribor, Faculty of electrical engineering and computer science, Maribor, Slovenija

Keywords: physics, electrotechnics, electronics, microelectronics, solar cells, solar cell models, spectral sensitivity, computer software, circuit analysis, SPICE computer program, photovoltaic field, photovoltaic field simulation, SEG, Solar Electric Generators, characteristics of solar electric energy generator

Abstract: The paper describes development of a computer solar cell model with the programme for circuit analysis SPICE. The basic goal of the development has been to unify previous simulators of I-V characteristics and to develop a solar cell model with a standard tool (e.g. SPICE) to enable cheaper research of the entire photovoltaic systems. The computer analysis of this problem does not require purchasing of expensive solar modules in the development phase. The results presented in the paper have been prepared using various analysis tools of the circuit analysis programme SPICE.

Izdelava modela sončne celice s programom za analizo vezij - SPICE

Ključne besede: fizika, elektrotehnika, elektronika, mikroelektronika, celice sončne, modeli celic sončnih, občutljivost spektralna, programi računalniški, analize vezij, SPICE program računalniški, polje fotonapetostno, simulacija polja fotonapetostnega, SEG generatorji elektrike sončne, karakteristike generatorja energije električne sončne

Povzetek: V članku je opisana izdelava računalniškega modela sončne celice s programom za analizo vezij SPICE. Osnovno vodilo pri izdelavi modela je bilo, poenotiti dosedanje simulatorje I-U karakteristik oz. z nekim standardnim orodjem (npr. SPICE) razviti model sončne celice in s tem omogočiti cenejše raziskave celotnega fotonapetostnega sistema. Z računalniško obdelavo tega problema namreč odpade v času razvoja nakup dragih solarni modulov. Rezultate sem prikazal s pomočjo analiz, ki jih omogoča program za analizo vezij SPICE.

1. INTRODUCTION

In the recent years there has been ever increasing interest for alternative energy sources, especially for solar energy. To successfully prevent possible energy crises in the future, it is necessary to develop technologies for exploitation of new energy sources.

A special attention is paid to the exploitation of solar energy. There are many advantages of solar energy and its use: The sun is inexhaustible source of energy, the use of solar energy does not pollute the environment (chemically, radioactively or thermally), with the use of solar systems we can save other fuels. However the introduction and exploitation of new energy sources cause a series of problems. The intensity of introduction of these sources depends on energy potential and time required for development of technologies for their exploitation. It will be possible to replace conventional energy sources by solar energy only when it will be cheaper than conventional sources. This energy source is because of certain drawbacks (acceptability, small density, unreliability) expensive and due to meteorological dependence often unreliable.

With the improvement of technologies for manufacturing of solar cells (cheapening) and increase of their efficiencies (better utilisation of solar energy) it is to expect that the technology of direct conversion of solar energy to electricity will become commercially successful.

The paper describes development of a computer solar cell model with the programme for circuit analysis

SPICE. The basic objective of the development has been to unify previous simulators of I-U characteristics and to develop a solar cell model with a standard tool (e.g. SPICE) to enable cheaper research of the entire photovoltaic systems. The computer analysis of this problem does not require purchasing of expensive solar modules in the development phase. The results presented in the paper have been prepared using various analyses tools of the circuit analysis programme SPICE.

According to the latest research results the direct conversion of solar energy to electricity should become one of the most important technology for exploitation of alternative energy sources.

2. SIMULATION OF SOLAR ELECTRIC GENERATOR'S CHARACTERISTICS

Often it is practically impossible to carry out experimental work with electric solar systems. This is true especially for high capacity commercial systems where each experimenting can cause unfavourable financial effect. On the other hand it is necessary to conduct research under strictly defined levels of solar radiation, which can only be achieved in laboratories. These problems can be avoided with the use of electronic circuits that enable a simulation of any configuration and capacity of electric solar system with a sufficient accurateness.

Below there is the description of the simulation of photovoltaic field with real electronic circuit, which is followed by the description of solar cell simulation using the programme for circuit analysis SPICE.

2.1 Simulation of Photovoltaic Field with Electronic Circuit

General shape of I-U characteristic of a solar electric generator (SEG), which should be produced by electronic simulator, is given in Figure 1.

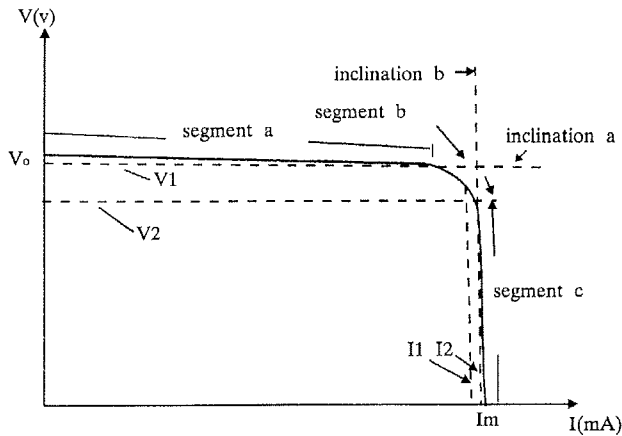

Figure 1: General shape of I-U characteristic of SEG

The distinctive shape of I-U characteristic of SEG consists of the following parts:

- a) Straight line that corresponds to the segment „a” between zero current and I_1 ;
- b) Exponential segment of the curve „b” corresponds to current in the range between I_1 and I_2 ;
- c) Second part of the straight line that corresponds to the segment „c” between I_2 and I_m .

The first linear segment is determined by the internal resistance of the SEG, to which corresponds the inclination of the tangent to the curve. The same holds for the third segment, the only difference is different value of resistance due to the changed inclination. In the middle there is the exponential segment “b” that connects both linear segments “a” and “c”. In the segment “b” the internal resistance is changing along its entire length.

Because of the above facts the problem of simulation of such curve with electronic configuration leads to the defining of source with controlled variable internal resistance and adaptable feedback, which enables simulation of variable internal resistance of SEG.

2.1.1 Block Diagram of the Photovoltaic Simulator

Electronic structure that operates as a simulator consists of the following parts:

- a) Source of DC current;
- b) Element for shaping of power;
- c) Sensor of current;
- d) Exponential multiplier;
- e) Control element.

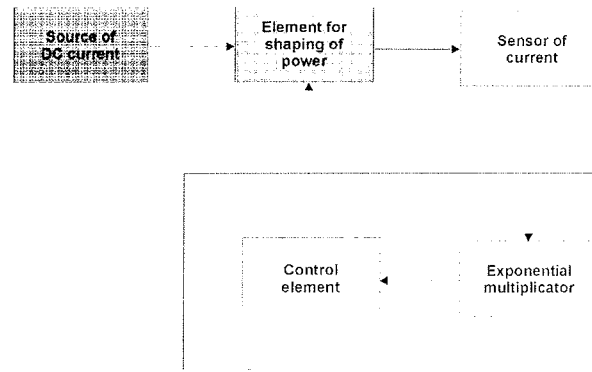

Figure 2: Block diagram of photovoltaic generator

2.2 Simulation of Solar Cell Model with the Programme for Circuit Analysis SPICE

So far, for the simulation of photovoltaic systems special programme packages have been developed. Their drawback was that they were not general programmes but adapted to the needs of each application. Such approach has led to the development of non-standard simulation tools. To overcome this problem it is necessary to apply standard programme package - simulator for simulation of electronic circuits and to build inside it a circuit that will serve as a model. The main advantage of such model is its increased flexibility. When the model is built it is possible to simulate with it any system only with a change of its individual components, according to the parameters of the system.

The simulator itself enables setting of all voltages and currents on its terminals, and also different types of circuit analysis.

2.2.1 Modelling of Components

In the designing phase of the sub-circuit consisting of electronic components in the programme SPICE, which should model the operation of a solar cell, the following parameters have to be taken into account:

- a) Area of the cell (A)
- b) Serial resistance (R_s)
- c) Parallel resistance (R_p)
- d) Ideality factor of the diode (n)
- e) Short circuit current (I_{sc})
- f) Temperature coefficient for I_{sc} (Coef. I_{sc})
- g) Open circuit voltage (U_{oc})
- h) Energy gap of the junction (E_g)
- i) p-layer (p_{gap})
- j) n-layer (n_{gap})

Material of the solar cell can be either silicon or amorphous silicon.

The values of current I_{sc} and voltage U_{oc} are defined for standard conditions, i.e. irradiation 1 kWm^{-2} (AM 1.5)

and temperature 300K. If we wish to change conditions of irradiation and temperature during the simulation - for instance if the time of simulation is one day or more - we have to plan additional elements inside the sub-circuit and enable access to the terminals of these elements. For this purpose we use controlled voltage generators which allow simulation of constant, cosine or any other shape of changing of irradiation and temperature.

Figure 3 shows block diagram of the structure of the sub-circuit representing solar cell. The input parameters that are shown by arrows have numerical values, while the terminals represent inputs and outputs of the circuit.

Terminals 1 and 2 represent positive and negative output (V), while terminals 3 and 4 represent the following two inputs:

- Input 3 gives changing of irradiation with time (Wm^{-2})
- Input 4 gives changing of temperature with time ($^{\circ}C$)

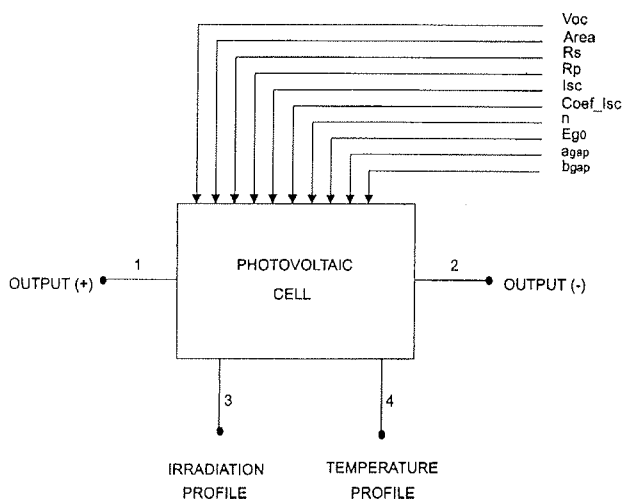

Figure 3: Parameters and input/output terminals of the sub-circuit that models solar cell in SPICE

Figure 4 shows the equivalent electronic circuit. All controlled sources are represented with squares. The controlled sources enable representation of the following quantities:

- Voltage controlled current source (G-irad): represents current, generated by light. Control voltage represents actual radiation profile in (Wm^{-2}) with which we control G-irad
- Voltage controlled current source (G-tidioid): represents dark current of diode, this is the current that flows through the cell when it is not irradiated. If it changes with time we have to control G-tidioid with E-temp.
- Voltage controlled voltage source (E-ininas): represents inverse saturation current of diode.
- Voltage controlled voltage source (E-temp): represents absolute temperature in (K)

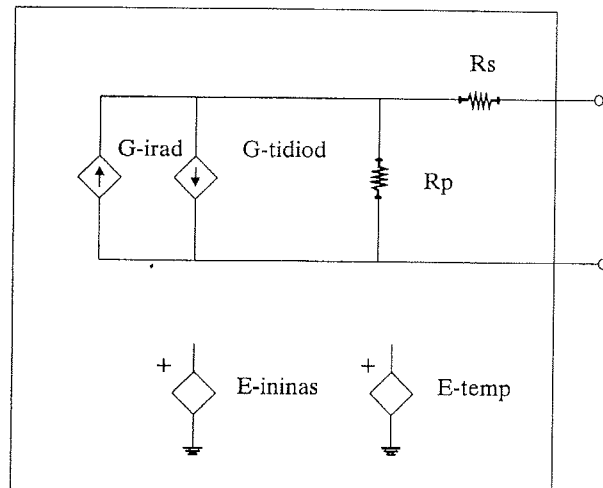

Figure 4: Equivalent diagram of circuit for solar cell

Photovoltaic modules are now modelled in such a way that more equivalent circuits, connected in series, as shown in Figure 4, are used. These composed modules can be connected in series or in parallel, so the solar fields can be composed.

The most important advantage of such approach to modelling, where each cell is modelled separately, is that it is relatively simple to simulate I-U characteristic of a real module or field. In this way different values of irradiation in each cell are taken into account, as well as different serial resistances R_s , parallel resistances R_p in ideality factors of diodes n , which are different for each cell.

2.2.2 Equivalent Model of Circuit

The first step of the designing of the equivalent circuit was designing of the generator or light source. This generator was conceived as a source with which the spectral sensitivity of the solar cell's material was simulated. With the voltage waveform, obtained at the generator terminals, the voltage controlled current source was controlled.

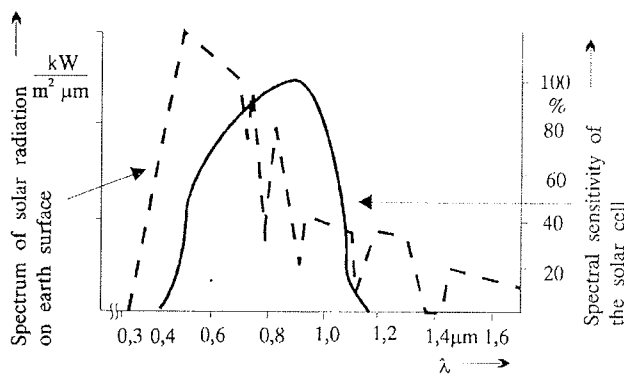

Figure 5: Spectral distribution of solar radiant energy (on the earth surface) and spectral sensitivity of the solar cell

For the solar cell efficiency it would be ideal if the spectral sensitivity of the material was wider than the solar spectrum. With this the entire solar spectrum that penetrates through the atmosphere to the surface would be taken into account. As can be seen from the Figure 5 this is not the case for silicon, therefore the voltage waveform at the generator terminals was shaped in accordance with this diagram.

Generator that represents solar source, with which spectral sensitivity of the solar cell's material was simulated, consists of the following components:

- impulse generator
- resistor attenuator, consisting of resistors and diodes

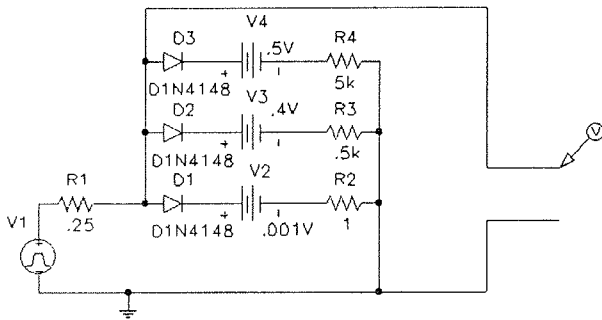

Figure 6: Generator - circuit for simulation of spectral sensitivity of solar cell material

Waveform of output voltage at the terminals of the generator (circuit for simulation of spectral sensitivity of solar cell material) is shown in Figure 7.

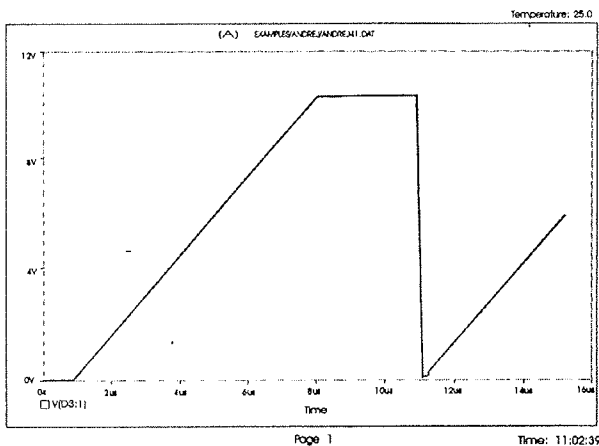

Figure 7: Output voltage on the generator terminals

This voltage was determined with transient analysis of the circuit that is enabled by the programme for circuit analysis SPICE.

In the next stage the equivalent circuit of the solar cell was modelled. Solar cell can be represented as an electronic circuit that is shown in Figure 8.

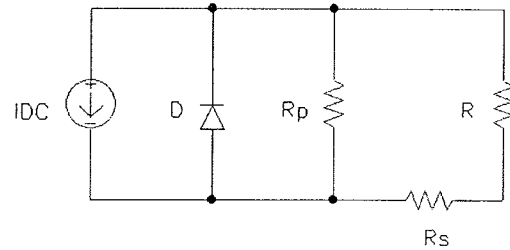

Figure 8: Electric equivalent circuit of the solar cell

The roles of different components of the circuit are as follows:

- source of constant current IDC: simulates current that flows when the cell is irradiated
- - diode D: simulates the reverse current of the solar cell, it also simulates the following parameters: ideality factor of diode (n), widths of n and p layer of semiconductor (a_{gap}) and (b_{gap})
- - parallel resistance R_p : simulates faults in the solar cell material
- - serial resistance R_s : simulates resistance of solar cell contacts

Both equivalent circuits have to be connected and an analysis in the programme for circuit analysis SPICE has to be carried out. Generator (equivalent circuit for simulation of spectral sensitivity of solar cell material) is connected to the equivalent circuit of the solar cell via a voltage controlled current generator.

Figure 9 shows the complete model of solar cell.

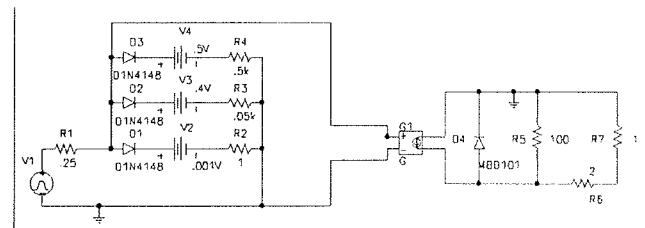

Figure 9: Complete model of solar cell

3. RESULTS

The purpose of these simulations was to obtain with the model such I-U characteristics that will be at the same conditions comparable with measured I-U characteristics of real solar cells.

Below there is a comparison of results for different values of irradiation of solar cells: I-U characteristic of real solar cell against I-U characteristic of the model.

Programme for circuit analysis SPICE was used for the simulation of characteristics of solar cell model. DC analysis was used for analysis of solar cell model.

3.1 Presentation of Simulation Results

For the measurements, a solar cell manufactured by Rade Končar, was used.

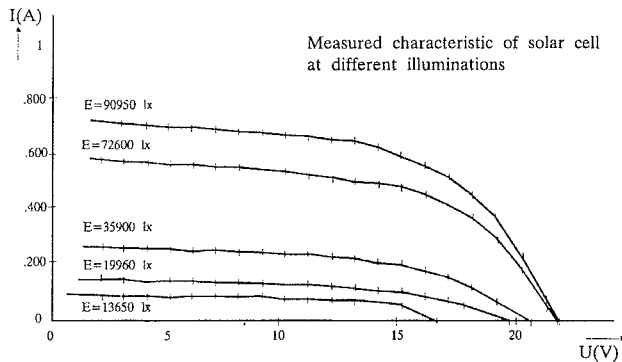

Fig. 10: Presentation of all measured characteristics of the real cell

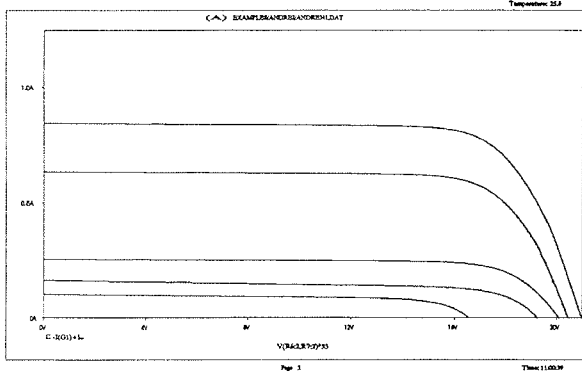

Fig. 11: Presentation of all simulated characteristics of the model

4. CONCLUSIONS

For the development of the solar cell model the MicroSim Corporation's programme for circuit analysis SPICE, development version 6.1a, was used. With this programme the output characteristics of the solar cell model were also analysed. These characteristics were compared with measured output characteristics of real solar cells. The comparison of measured and real output I-U characteristics shows that they are identical.

This analysis showed that the use of the programme SPICE for the simulation of photovoltaic systems gave results, comparable with real systems. Such approach to the analysis of photovoltaic systems also offers a quick insight in all voltages and currents in the system, gives a lot of possibilities for changing of circuit topology and enables an easy connection with standard electronic devices.

The era of cheap and always available energy is slowly coming to an end. In the future the real energy price will also include the costs of processing and storage of radioactive wastes, costs of interventions in the case of natural catastrophes caused by the climate changes, costs of removing the oil spills, etc. Solar energy is friendly for the environment, therefore it is expected that its importance will increase in the future. Standardised computer aided approach will make the development of photovoltaic systems cheaper, since the technological development in this field still does not follow the needs.

5. REFERENCES

- [1] Z. Todorovič: "Solarni generatori u primeni" Beograd 1989
- [2] L. Castaner, R. Aloy, D. Carles: "Photovoltaic System Simulation Using a Standard Electronic Circuit Simulator" Progres in photovoltaics p.239-253 July 1995
- [3] H. G. Wagemann: "Optoelektronische halbleiterbauelemente" Technische Universität Berlin 1978
- [4] Tadej Tuma: "Analiza vezij s programom SPICE", Ljubljana 1992

Assoc. Prof. Ph.D. Jože Voršič
 Assistant Andrej Hanžič, B.Sc.E.
 University of Maribor, Faculty of Electrical Engineering and Computer Science
 Smetanova 17, 2000 Maribor, Slovenia
 Tel: + 386 62 221 112
 Fax: + 386 62 225 013
 Email: andrej.hanzic@uni-mb.si

Prispelo (Arrived): 27.5.00

Sprejeto (Accepted): 30.8.00