

ON COST FUNCTION PROPERTIES IN ANALOG CIRCUIT OPTIMIZATION

Andrej Nussdorfer, Árpád Búrmen, Janez Puhan and Tadej Tuma

University of Ljubljana, Faculty of electrical engineering, Ljubljana, Slovenija

Key words: computer aided design, analog circuits, optimization algorithms, cost function, parameter space

Abstract: Analog circuit design is a very complex and time consuming process. The largest percentage of the time is spent trying to achieve the best performance by varying the circuit parameters. This is actually an optimization process and there is a growing desire to automate at least a part of the optimization procedure. Unfortunately the optimization algorithms are still very slow. This is mostly due to the sheer number of circuit analyses it takes for the optimization algorithm to converge to a minimum. Obviously any previous knowledge about the shape of the cost function could help the optimization algorithm to converge faster. Unfortunately (again) the shape of the cost function is generally too unpredictable to draw any conclusions prior to the optimization run. This paper tries to show that with a special formulation of the cost function the shape of the cost function itself can be at least partially predicted.

Vpogled v značilnosti kriterijskih funkcij optimizacijskih algoritmov

Ključne besede: računalniško podprto načrtovanje, analogna vezja, optimizacijski algoritmi, kriterijska funkcija, parameterski prostor

Izvleček: Načrtovanje analognih vezij je zelo zapleten postopek, najtežji del katerega pa je zagotovo določanje optimalnih vrednosti parametrov vezja. Pri tem gre v bistvu za optimizacijski postopek, kjer načrtovalec s spreminjanjem vrednosti parametrov skuša doseči čim boljše delovanje vezja. Zaradi zahtevnosti postopka se pojavlja vse večja želja po določeni avtomatizaciji, to je uporabi optimizacijskih algoritmov za določanje teh parametrov. Žal so optimizacijski algoritmi zelo zamudni, to pa zaradi velikega števila analiz, ki jih morajo opraviti. Vsaka vnaprejšnja informacija o lastnostih kriterijske funkcije je zato zelo dobrodošla saj lahko skrajša čas optimizacije. V splošnem velja, da je oblika kriterijske funkcije nepredvidljiva. Ta članek skuša nakazati, da je v določenih primerih mogoče obliko kriterijske funkcije do določene mere vnaprej predvideti.

1. Introduction

Analog circuit design is a very complicated job. An engineer performing it must be highly skilled and must possess an intimate knowledge of circuit topologies. In addition he must have a fairly high amount of patience. The problem lies in the fact that analog circuit design is a trial and error process. As the complexity of analog circuits grows it becomes practically impossible to compute the circuit parameters analytically. The designer has to vary the circuit parameters and simulate the circuit in hope of finding the optimal set of values. As this is actually an optimization problem there is a growing desire to employ optimization algorithms to automate at least part of the task [5-9].

The main reason for computer circuit optimization not to be widely used in circuit design is the computational intensity of optimization algorithms. Although the raw computing power of modern computers is steadily increasing the length of optimization runs is still measured in days. The sheer number of circuit analyses the algorithms require and the size of the parameter space are the main reasons for the slow convergence rate. It is understandable that there is a strong interest in the designer community for such tools and much effort has been (and still is) poured into the investigation of various optimization algorithms. The focus of this research is the minimization of the required number of circuit analyses to perform an optimization run. It is interesting to note that all the research has been fo-

cused on the optimization algorithms alone and that the formulation of the cost function has been left untouched.

At first glance this would seem reasonable enough as common sense indicates that the behavior of the optimized circuit should vary unpredictably across the parameter space investigated by the optimization algorithm. While this is usually true there are certain cases where the behavior of the cost function in the parameter space can be at least partially predicted and taken into account by the optimization algorithm.

This paper tries to shed some light on the properties of an analog circuit cost functions.

The paper is partitioned as follows. First the cost function formulation is explained. A mathematical analysis of the resulting cost function follows. The analytical results are then substantiated by the numerical results of optimization runs on real world circuits. Finally the conclusions are summed up and some suggestions for future work are given.

2. The cost function formulation

The behavior of a circuit can be described with a number of measurements. More detailed the description must be, more measurements it takes. This is also true for optimization algorithms. The cost function is usually defined as a

function of a set of measurements, which are in turn the results of circuit simulations. In most cases this is an ordinary linear combination of suitably weighted measurement values.

$$cost(x) = \sum_i a_i * measurement_i(x) \quad (1)$$

Although some research has been done into cost function formulation it was mainly centered around the robustness of the resulting optimized circuit /1-4/ while little thought has been spent on the possible implications for the optimization algorithm. Even if this work /1,2/ is not directly connected to the investigated problem it can nevertheless form a solid base for the analysis of the cost function behavior. Before proceeding further with the task it would be best to examine the proposed cost function formulation.

As mentioned earlier the cost function is usually a linear combination of suitably weighted measurement values. The investigated cost function formulation takes a different approach. Instead of combining the measurement values directly a set of criterion functions is built. These criterion functions are actually nonlinear transformations that translate measurement values into cost values. These cost values are then summed up and form the cost function itself. The criterion functions are defined in expression (2).

$$cost(x) = \begin{cases} -k_l(x_G - x) & : x \leq x_G \\ k_p(x - x_G) & : x \geq x_G \end{cases} \quad (2)$$

The situation is shown in figure 1.

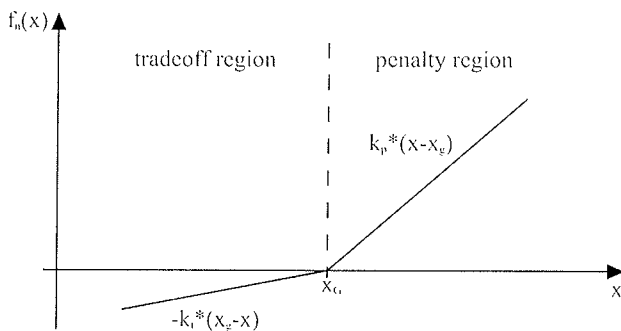

Figure 1: A graphical representation of a criterion function

Geometrically the criterion function is the combination of two ramps. The criterion function has two regions, one is the tradeoff region and the other is the penalty region. A measurement value in the penalty region means a working circuit with lower than specified characteristics that is penalized with a positive cost value. A measurement in the tradeoff region belongs to a circuit that meets the design specification and so it is awarded with a negative cost value.

Another important concept in robust circuit design that needs underlining is corners. A corner is simply put a set of circuit operating parameters. These can be environmental parameters (temperature, humidity), process param-

eters (process and element tolerances) and operating conditions (supply voltage).

Optimization results /1,2/ have already shown that this cost function formulation yields robust circuit designs. Now it must be seen whether there is anything that can be done analytically.

3. Mathematical analysis

The problem that will be investigated is the behavior of the cost function when the number of criterion functions increases. To tackle this problem it must be simplified first.

There is a number of assumption to be made to make the analytical approach manageable. First only a bounded region of the measurement space will be observed. Second the criterion functions will be evenly spaced across the observed interval of the measurement space. The slopes of all criterion functions will be equal. Fourth the tradeoff coefficients will be all 0.

Even if this set of assumptions seems very restrictive there will still be a number of useful conclusions to be drawn from the results. The described configuration is depicted in figure 2.

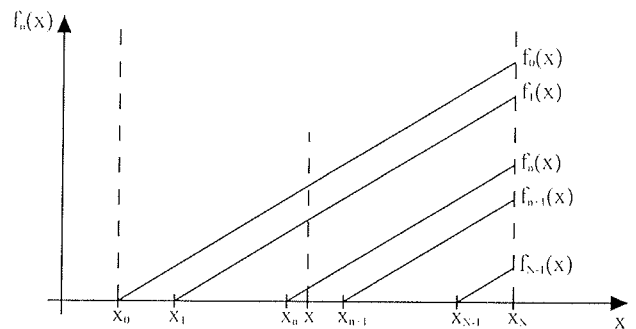

Figure 2: The investigated scenario

The notation is as follows: x_0 and x_N are the limits of the observed region, N is the number of ramps, x_n are ramp starting points and x is an arbitrary point in the observed region. The ramps are defined in equation (3).

$$f_n(x) = \begin{cases} k(x - x_n) & : x \geq x_n \\ 0 & : otherwise \end{cases} \quad (3)$$

The difference between two consecutive x_n is d . An arbitrary point x is then defined in equation (4).

$$x = x_0 + t(x_N - x_0) = x_0 + tNd \quad (4)$$

and the ramp starting points is expressed in equation (5).

$$x_n = x_0 + nd = x_0 + [tN]d \quad (5)$$

The cost function is then the sum of all ramp functions in the observed interval of the measurement space.

$$F_N(x) = \frac{1}{N} * \sum_{n=0}^N f_n(x) \quad (6)$$

Expression (6) is still general but after the substitution of $f_n(x)$ with the ramp function definition (expression (3)) the cost function expression (7) is obtained.

$$\begin{aligned} F_N(x) &= \frac{1}{N} * \sum_{n=0}^{\lfloor tN \rfloor} k(x - (x_0 + nd)) = \\ &= \frac{k}{N} \sum_{n=0}^{\lfloor tN \rfloor} (x - x_0) - \frac{kd}{N} \sum_{n=0}^{\lfloor tN \rfloor} n = \\ &= \frac{\lfloor tN \rfloor + 1}{N} k(x - x_0) - \\ &\quad \frac{kd \lfloor tN \rfloor (\lfloor tN \rfloor + 1)}{2N} \end{aligned} \quad (7)$$

This expression can be improved with the introduction of a new variable ϵ .

$$\begin{aligned} \lfloor tN \rfloor &= (t - \epsilon)N = tN - \epsilon N \\ \epsilon &= \frac{tN - \lfloor tN \rfloor}{N} \leq \frac{1}{N} \end{aligned} \quad (8)$$

The floor ($\lfloor tN \rfloor$) notation in expression (7) can now be substituted with expression (8) to get the equation (9).

$$\begin{aligned} F_N(x) &= \frac{(t - \epsilon)N + 1}{N} k(x - x_0) - \\ &= \frac{k \frac{x_N - x_0}{N} (t - \epsilon)N ((t - \epsilon)N + 1)}{N} = \\ &= ((t - \epsilon) + \frac{1}{N}) k(x - x_0) - \\ &= k(x_N - x_0) \frac{(t - \epsilon)^2}{2} - \frac{(x_N - x_0)(t - \epsilon)}{2N} k \end{aligned} \quad (9)$$

Apart from the simplification of equation (7) expression (8) presents an upper bound for ϵ , which will be useful later.

In expression (9) the cost function is dependent on the number of criterion ramp functions N . Since the number of criterion functions is the product of the number of measurements and corners it tends to get very large. It will prove useful to compute the limit of the cost function with N approaching infinity. The result is expression (10).

$$\lim_{N \rightarrow \infty} F_N(x) = k(x - x_0)t - \frac{k}{2}(x_N - x_0)t^2 \quad (10)$$

Notice that both x and t are present in expression (10). Since they are both rigidly tied by expression (4) equation (10) can be expressed with just one of them. The variable t can be expressed from equation (4).

$$t = \frac{x - x_0}{x_N - x_0} \quad (11)$$

The resulting expression (11) can then be substituted in equation (10).

$$\begin{aligned} \lim_{N \rightarrow \infty} F_N(x) &= k \frac{(x - x_0)^2}{x_N - x_0} - \frac{k}{2} \frac{(x - x_0)^2}{x_N - x_0} = \\ &= \frac{k}{2(x_N - x_0)} (x - x_0)^2 = \alpha * (x - x_0)^2 \end{aligned} \quad (12)$$

The resulting expression (12) is obviously a quadratic function of variable x . The conclusion that can be drawn is that the larger is the number of criterion functions the more the cost function resembles half a quadratic parabola.

The obtained result applies directly only to the minimization of measurement values. It would be straightforward to show that the same result follows from the analysis of a measurement maximization criterion function.

Notwithstanding the interesting results it must be born in mind that the analysis was done in measurement space. The relationships between circuit parameters and measurement values are highly nonlinear. Further the assumptions that were made are generally not fulfilled. It must therefore be expected that the shape of the cost function in the parameter space will not be an ideal quadratic parabola. All that needs to be done is to check whether the analytical results resemble in any way real optimization data obtained on a real world test circuit.

4. The test circuit

The test circuit is the core segment of a real world operational amplifier. The heart of the amplifier is a differential telescopic amplifier stage. The stage consists of transistors m06-m15. There is also a simplified bias circuitry (m01-m05) where a complex compensation circuit is substituted by two current sources (i01 and i02) and a common mode feedback circuit (m17-m20). The bias circuit has also a temperature compensation made of the transistors m04 and m05 and the resistor r01. The schematic diagram of the operational amplifier is shown in figure 3. Figure 4 shows the test application of the operational amplifier.

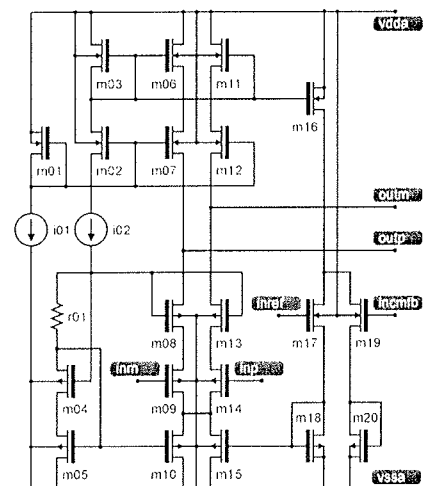

Figure 3: The schematic diagram of the simplified operational amplifier

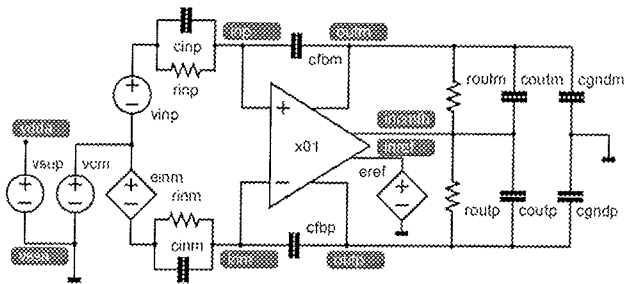

Figure 4: Operational amplifier test application

The test-bench circuit simulates the working condition of the operational amplifier. The element values are: r_{inp} and r_{inm} are both $1\text{m}\Omega$, r_{outp} and r_{outm} are both $1\text{G}\Omega$, c_{inp} , c_{inm} , c_{fbp} and c_{fbm} are all 500fF , r_{outp} and r_{outm} are both 150fF and c_{gndp} and c_{gndm} are both 2.3pF .

There are 18 matching groups of optimization parameters in the circuit. These are:

- 1) the lengths of transistors m03, m06, m11 and m16
- 2) the lengths of transistors m02, m07 and m12
- 3) the lengths of transistors m18 and m20
- 4) the lengths of transistors m08 and m13
- 5) the lengths of transistors m09 and m14
- 6) the lengths of transistors m05, m10 and m15
- 7) the lengths of transistors m17 and m19
- 8) the length of transistor m01
- 9) the length of transistor m04
- 10) the widths of transistors m02, m03, m06, m07, m11, m12 and m16
- 11) the widths of transistors m18 and m20
- 12) the widths of transistors m08 and m13
- 13) the widths of transistors m09 and m14
- 14) the widths of transistors m05, m10 and m15
- 15) the widths of transistors m17 and m19
- 16) the width of transistor m01
- 17) the width of transistor m04
- 18) the multiplication factors of transistors m10 and m15

From the matching groups it is evident that channel widths and lengths of all transistors are optimized in addition to the multiplication factors of transistor m10 and m15.

There are also 9 corners involved in the circuit evaluation.

There are 11 design goals the optimization algorithm must fulfill. These are:

- Maximum current consumption 0.48mA
- Maximum common mode feed-back offset 180mV
- Minimum output swing 2.6V
- Minimum open loop gain 61dB
- Minimum unity gain frequency 90MHz
- Minimum phase margin 75°

- Minimum gain margin 13dB
- Maximum overshoot 0.3%
- Maximum settling time 11ns
- Minimum slew rate 13MV/s

Each design goal is checked with a suitable measurement. Combined with the number of corners this means the cost function consists of 99 criterion functions. All trade-off weights are set to 0 and all penalty weights are set to 1.

Now the optimization problem has been introduced it is time to see the results.

For the sake of clarity only 5 matching group cost profiles out of the 18 will be shown. There are the matching groups 8, 12, 13, 16 and 18.

Figures 5-9 show the cost profiles of the cost function for the chosen axes of the parameter space. On each figure there are the profiles of the nine separate corners (thin lines) together with the complete cost function (bold line).

As expected the cost function profiles are not exactly quadratic parabolas. Nevertheless it is still notable that they are quite smooth and near the optimal parameter values they are remarkably quadratic-like, specially in the neighborhood of the cost function minimum. This seems to imply that the relationship between the cost function in the measurement space and the cost function in the parameter space becomes linear in the vicinity of the cost function minimum but additional research would be needed to shed more light on the subject.

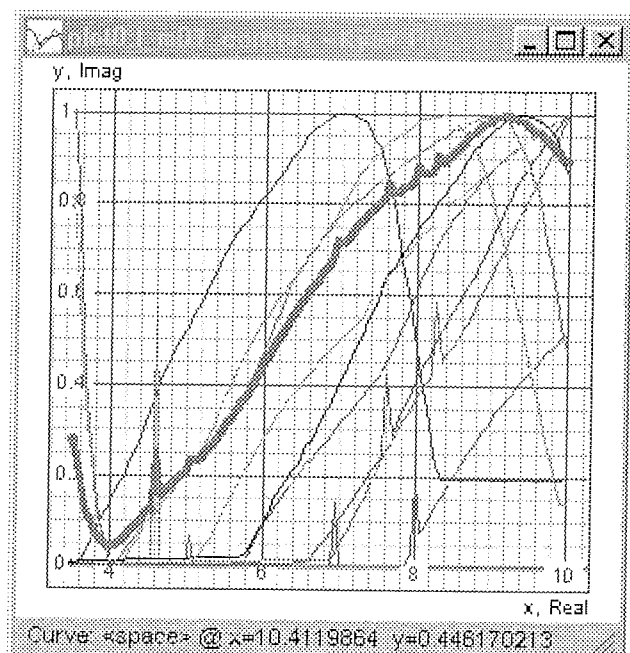

Figure 5: The cost profiles as functions of the matching group 8.

The profiles in figures 5,6 and 7 are reasonably close the predictions. There is only the question about the spikes

that are present on the otherwise smooth curves. Before delving into those it is noteworthy to have a look at figure 8. In this figure the profiles are full of spikes. A careful analysis of the measurement values near the spikes revealed that the spikes are caused by numerical noise that should have been foreseen.

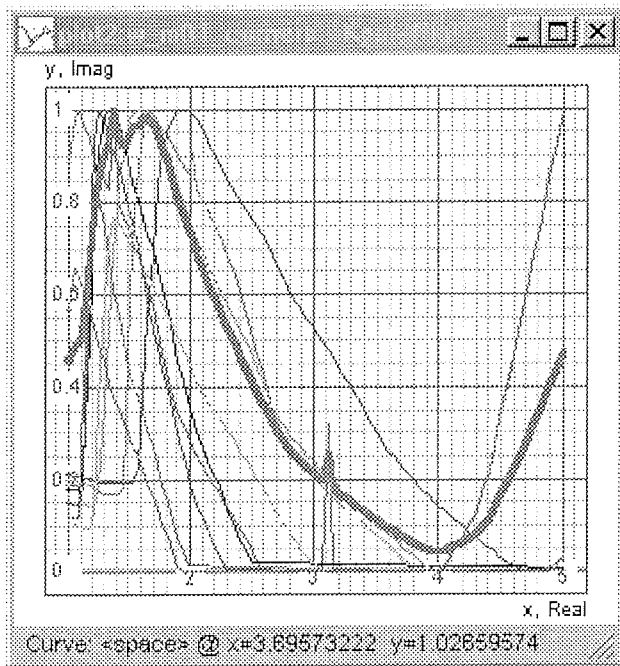

Figure 6: The cost profiles as functions of the matching group 16.

The main reason for the spikes is the far too tight overshoot design goal. With such a pressing goal it is normal that the circuit will hover just below the required performance. In such a situation any numerical error in the measurement computations can result in a worse than required performance causing the observed spikes. In figures 5, 6 and 7 the measurements were well clear of the goal threshold so there is a limited number of spikes. In the case of figure 8 on the other hand the circuit hovers right on the goal threshold with the result that the cost profile is extremely noisy. When the spikes are taken into account it can be seen that even the cost profile in figure 8 is reasonably like the profiles in figures 5, 6 and 7.

The remaining cost profile in figure 9 differs from the others in one point. It is not smooth. On this figure the cost profile is the function of the multiplication factor of transistors m10 and m15. Since the multiplication factor is an integer value the steps in the cost profile are expected. Non-smooth cost functions are still a major problem for optimization algorithms /10-13/ so it is remarkable that the optimization algorithm /8,9/ successfully converged to the minimum with little trouble.

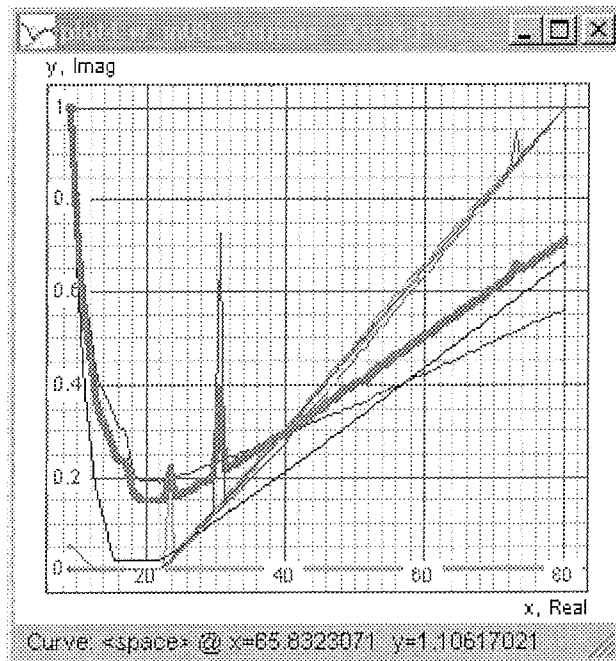

Figure 7: The cost profiles as functions of the matching group 12.

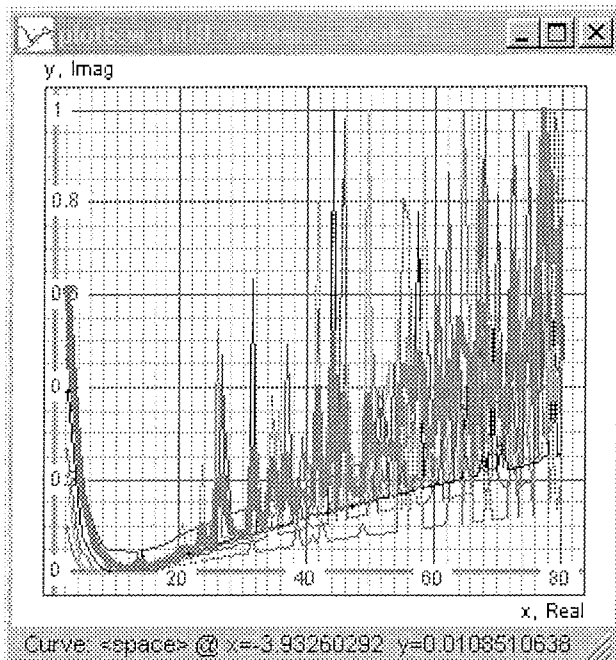

Figure 8: The cost profiles as functions of the matching group 13.

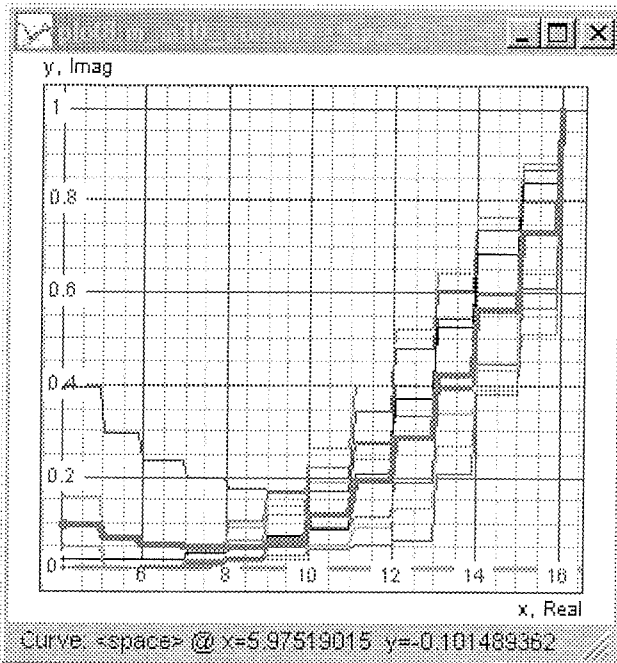

Figure 9: The cost profiles as functions of the matching group 18.

5. Conclusions

The evidence presented in this paper leads to several conclusions.

First, the cost function in the measurement space is shown analytically to limit to a quadratic parabola. This is due to the formulation of the cost function /1,2/ and the presence of a large number of corners and measurements needed for a robust circuit design /1-4/. Even if the relationship between measurement space and parameter space cost functions is highly nonlinear this result can still prove highly useful.

Second, the cost function of a real-world integrated operational amplifier was studied. The cost function profiles showed a general smoothness while in the vicinity of the minimum the cost function profile displayed a near quadratic shape. This seems to imply that the relationship between measurement space cost functions and parameter space cost functions tends to become linear in the vicinity of the minimum. If proved true this would be in itself a most remarkable result but at this stage it is still too early to draw a definite conclusion. Additional research is needed to shed more light into this subject.

Third, the quadratic shape of the cost function in the vicinity of the minimum suggests the development of an optimization algorithm that could exploit such cost function properties. The fact that the quadratic shape is present only in the vicinity of the minimum a multi-stage optimization algorithm is needed. Multi-stage optimization algorithms have been investigated in the past /14-18/ but unfortunately the research was centered on the algorithms themselves

without delving into the properties of the underlying cost functions. It would be expected that the exploitation of the quadratic near-minimum cost function shape could help the convergence of optimization algorithms. To build such a multi-stage optimization algorithm suitable basic optimization algorithms would have to be chosen first, then an adequate algorithm for dynamically switching to the appropriate optimization method based on the cost function properties would have to be developed.

6. References

- /1/ A. Burmen, J. Puhan and T. Tuma, *Defining cost functions for robust IC design and optimization*, Design, Automation and Test in Europe 2003, pg. 196-201, 2003
- /2/ A. Burmen, D. Strle, F. Bratkovič, J. Puhan, I. Fajfar and T. Tuma, *Automated robust design and optimization of integrated circuits by means of penalty functions*, AEU International journal of electronics and communications, vol. 57/1, pg. 47-56, 2003
- /3/ M. del Mar Hersherson, S.P. Boyd, T.H. Lee, *Optimal design of a CMOS op-amp via geometric programming*, IEEE transactions on computer aided design of integrated circuits and systems 20, pg. 1-21, 2001
- /4/ K. Krishna, S.W. Director, *The linearized performance penalty (LPP) method for optimization of parametric yield and its reliability*, IEEE transactions on computer aided design of integrated circuits and systems 14, pg. 1557-1568, 1995
- /5/ G.G.E. Gielen, R.A. Rutenbar, *Computer aided design of analog and mixed-signal integrated circuits*, Proceedings of the IEEE 88, pg. 1825-1854, 2000
- /6/ P.R. Gray, P.J. Hurst, S.H. Lewis, R.G. Meyer, *Analysis and design of analog integrated circuits*, New York, USA: John Wiley & Sons, 2001
- /7/ A.R. Conn, N.I.M. Gould, P.L. Toint, *Trust-region methods*, Philadelphia, USA: SIAM, 2000
- /8/ J. Puhan, T.Tuma, *Optimization of analog circuits with SPICE3F4*, Proceedings of 1997 European conference on circuit theory and design, vol.2, pg. 177-180, 1997
- /9/ J. Puhan, T.Tuma, I. Fajfar, *Optimization methods in SPICE: a comparison*, Proceedings of 1999 European conference on circuit theory and design, vol.2, pg. 1279-1282, 1999
- /10/ J.E. Dennis, S.B. Li and R.T. Tapia, *A unified approach to global convergence of trust region methods for non-smooth optimization*, Mathematical programming 68, pg. 319-346, 1995
- /11/ L. Gerencser, G.Y. Kozmann, Z.S. Vago, *Non-smooth optimization via SPSA*, Proceedings of the Conference on the mathematical theory of networks and systems, pg. 803-806, 1998
- /12/ L. Gerencser, G.Y. Kozmann, Z.S. Vago, *SPSA for non-smooth optimization with application in ECG analysis*, Proceedings of the 37th IEEE conference on decision and control, pg. 3907-3908, 1998
- /13/ R.B. Kearfott, *Treating non-smooth functions as smooth functions in global optimization and nonlinear systems solvers*, Scientific computing and validated numerics, Mathematical research, 1995
- /14/ J. Scaepperle, E. Luder, *Optimization of distributed parameter systems with a combined statistical - deterministic method*, 1994 IEEE International symposium on circuits and systems, vol. 6, str. 141-144, 1994
- /15/ J. Nocedal, Y. Yuan, *Combining trust region and line search techniques*, in: Y. Yuan (Ed.), *Advances in nonlinear programming*, str. 153-176, 1998
- /16/ E.M. Gertz, *Combination trust region line search methods for unconstrained optimization*, Ph.D. thesis, Department of mathematics, University of California, San Diego, 1999

- /17/ T. Van Le, *A fuzzy evolutionary approach to solving constraint problems*, Second IEEE conference on evolutionary computation, vol. 1, str 317-319, 1995
- /18/ Q. Zhang, J. Sun, E. Tsang in J. Ford, *Combination of guided local search and estimation of distribution algorithm for quadratic assignment problems*, Proceedings of the Bird of a Feather workshops, Genetic and evolutionary computation conference, str.42-48, 2003

*Andrej Nussdorfer, Árpád Bűrmen, Janez Puhan and
Tadej Tuma
University of Ljubljana
Faculty of Electrical Engineering
Tržaška 25, SI-1000 Ljubljana, Slovenija
E-mail: andrej.nussdorfer@fe.uni-lj.si*

7. Acknowledgements

The research was co-funded by the Ministry of Education Science and Sport (Ministrstvo za Šolstvo, Znanost in Šport) of the Republic of Slovenia through the programme P2-0246 – Algorithms and optimization methods in telecommunications.

Prispelo (Arrived): 02.06.2004 Sprejeto (Accepted): 20.06.2004